

Data sheet | Item number: 2202-1881

TOPJOB®S fuse terminal block with Push-buttons; rail mount; for mini-automotive blade-style fuses; 4-conductor; 5.2 mm wide; gray

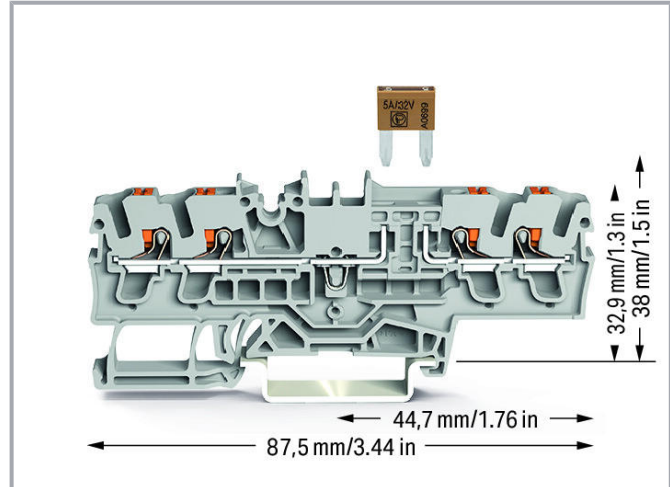

www.wago.com/2202-1881

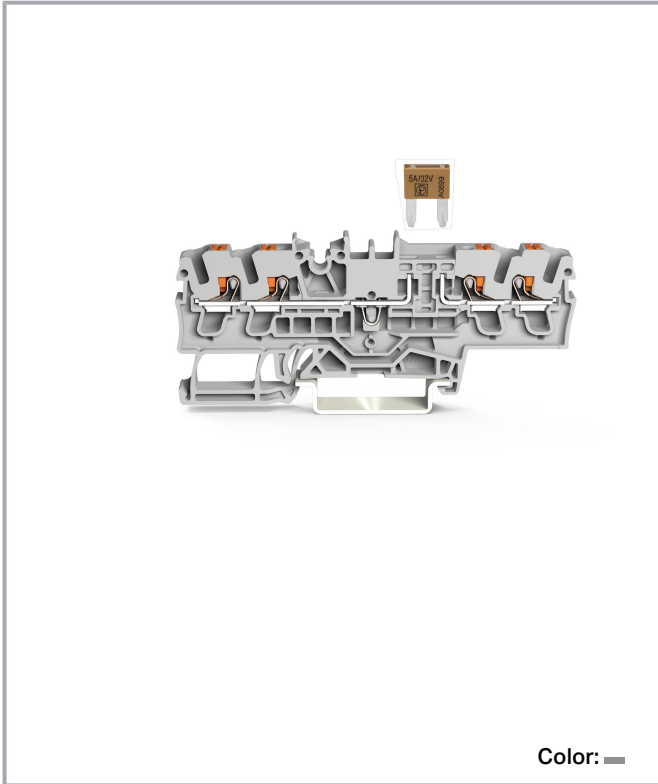

Color:

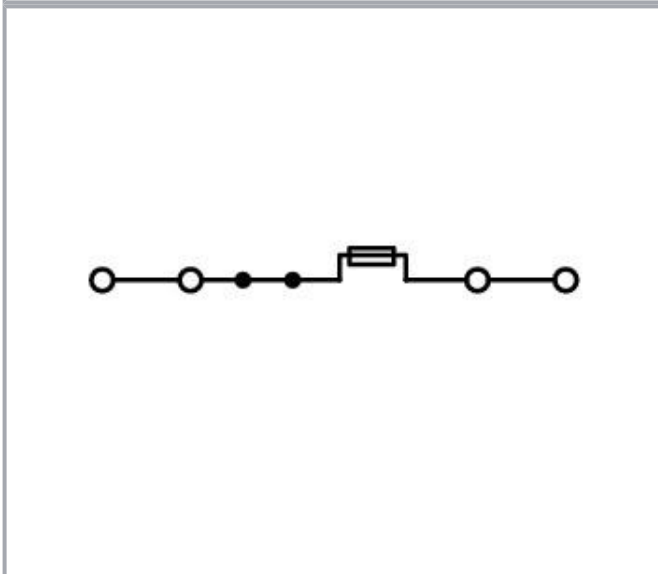

Subject to changes. Please also observe the further product documentation!

WAGO Corporation
Germantown, WI 53022
Phone: 1-800-DIN-RAIL (346-7245) | Fax: (262) 255-6222
Email: info.us@wago.com | Web: www.wago.us

Do you have any questions about our products?
We are always happy to take your call at (262) 255-6222 or 1 800-DIN-RAIL.



Item description

Safety information 1:

Electrical ratings are given by the fuse.

Safety information 2:

Blade-style fuses: Observe touch-proof protection for 42 V and higher voltages!

Data

Electrical data

IEC Approvals

Ratings per	IEC/EN 60947-7-3
Rated voltage (III / 3)	400 V
Rated surge voltage (III/3)	6 kV
Rated current	10 A
Legend (ratings)	(III / 3) \triangleq Overvoltage category III / Pollution degree 3

UL Approvals

Approvals per	UL 1059
Rated voltage UL (Use Group B)	300 V
Rated current UL (Use Group B)	10 A
Rated voltage UL (Use Group C)	300 V
Rated current UL (Use Group C)	10 A

CSA Approvals

Approvals per	C22.2 No 158
Rated voltage CSA (Use Group B)	300 V
Rated current CSA (Use Group B)	10 A
Rated voltage CSA (Use Group C)	300 V
Rated current CSA (Use Group C)	10 A

Connection data

Connection technology	Push-in CAGE CLAMP [®]
Actuation type	Push-button Push-in Open Tool Slot
Connectable conductor materials	Copper

Subject to changes. Please also observe the further product documentation!



	Copper
Nominal cross-section	2.5 mm ²
Solid conductor	0.25 ... 4 mm ² / 22 ... 12 AWG
Solid conductor; push-in termination	0.75 ... 4 mm ² / 18 ... 12 AWG
Fine-stranded conductor	0.25 ... 4 mm ² / 22 ... 12 AWG
Fine-stranded conductor; with insulated ferrule	0.25 ... 2.5 mm ² / 22 ... 14 AWG
Fine-stranded conductor; with ferrule; push-in termination	1 ... 2.5 mm ² / 18 ... 14 AWG
Note (conductor cross-section)	Depending on the conductor characteristic, a conductor with a smaller cross-section can also be inserted via push-in termination.
Strip length	10 ... 12 mm / 0.39 ... 0.47 inch
Total number of connection points	4
Total number of potentials	2
Number of levels	1
Wiring direction	Front-entry wiring
Number of jumper slots	2

Physical data

Width	5.2 mm / 0.205 inch
Height	87.5 mm / 3.445 inch
Depth from upper edge of DIN-rail	32.9 mm / 1.295 inch

Mechanical data

Design	horizontal type
Mounting type	DIN-35 rail
Marking level	Center/side marking
Art der Sicherung	Mini plug-in fuse 10.9 x 3.6 x 16.3 mm

Material data

Color	gray
Insulation material	Polyamide (PA66)
Flammability class per UL94	V0
Fire load	0.197 MJ
Weight	9.7 g

Commercial data

Packaging type	BOX
Country of origin	DE

Subject to changes. Please also observe the further product documentation!

WAGO Corporation
 Germantown, WI 53022
 Phone: 1-800-DIN-RAIL (346-7245) | Fax: (262) 255-6222
 Email: info.us@wago.com | Web: www.wago.us

Do you have any questions about our products?
 We are always happy to take your call at (262) 255-6222 or 1 800-DIN-RAIL.

GTIN	4055143902830
Customs tariff number	8536904000



Approvals / Certificates

Country specific Approvals

Logo	Approval	Additional Approval Text	Certificate name
	CSA DEKRA Certification B.V.	C22.2	701737745







Required accessories

End plates

	Item no.: 2002-1891 TOPJOB®S end/intermediate plate; for 2002-18xx series terminal blocks; 1.0 mm wide; gray	www.wago.com/2002-1891
	Item no.: 2002-1892 TOPJOB®S end/intermediate plate; for 2002-18xx series terminal blocks; 1.0 mm wide; orange	www.wago.com/2002-1892

Optional accessories

Marking accessories

	Item no.: 2002-121 Adaptor; gray	www.wago.com/2002-121
	Item no.: 2002-161 Adaptor; gray	www.wago.com/2002-161
	Item no.: 2009-110 Marking strips; for Smart Printer; on reel; not stretchable; plain; snap-on type; white	www.wago.com/2009-110
	Item no.: 2009-115 WMB-Inline; for Smart Printer; 1500 pieces on roll; stretchable 5 - 5.2 mm; plain; snap-on type; white	www.wago.com/2009-115
	Item no.: 2009-115/000-002 WMB-Inline; for Smart Printer; 1500 pieces on roll; stretchable 5 - 5.2 mm; plain; snap-on type; yellow	www.wago.com/2009-115/000-002
	Item no.: 2009-115/000-005 WMB-Inline; for Smart Printer; 1500 pieces on roll; stretchable 5 - 5.2 mm; plain; snap-on type; red	www.wago.com/2009-115/000-005
	Item no.: 2009-115/000-006 WMB-Inline; for Smart Printer; 1500 pieces on roll; stretchable 5 - 5.2 mm; plain; snap-on type; blue	www.wago.com/2009-115/000-006

Subject to changes. Please also observe the further product documentation!

WAGO Corporation
Germantown, WI 53022
Phone: 1-800-DIN-RAIL (346-7245) | Fax: (262) 255-6222
Email: info.us@wago.com | Web: www.wago.us















Do you have any questions about our products?
We are always happy to take your call at (262) 255-6222 or 1 800-DIN-RAIL.



*	Item no.: 2009-115/000-007 WMB-Inline; for Smart Printer; 1500 pieces on roll; stretchable 5 - 5.2 mm; plain; snap-on type; gray	www.wago.com/2009-115/000-007
*	Item no.: 2009-115/000-012 WMB-Inline; for Smart Printer; 1500 pieces on roll; stretchable 5 - 5.2 mm; plain; snap-on type; orange	www.wago.com/2009-115/000-012
*	Item no.: 2009-115/000-017 WMB-Inline; for Smart Printer; 1500 pieces on roll; stretchable 5 - 5.2 mm; plain; snap-on type; light green	www.wago.com/2009-115/000-017
*	Item no.: 2009-115/000-023 WMB-Inline; for Smart Printer; 1500 pieces on roll; stretchable 5 - 5.2 mm; plain; snap-on type; green	www.wago.com/2009-115/000-023
*	Item no.: 2009-115/000-024 WMB-Inline; for Smart Printer; 1500 pieces on roll; stretchable 5 - 5.2 mm; plain; snap-on type; violet	www.wago.com/2009-115/000-024
/	Item no.: 2009-145 Mini-WSB Inline; for Smart Printer; 1700 pieces on roll; stretchable 5 - 5.2 mm; plain; snap-on type; white	www.wago.com/2009-145
/	Item no.: 2009-145/000-002 Mini-WSB Inline; for Smart Printer; 1700 pieces on roll; stretchable 5 - 5.2 mm; plain; snap-on type; yellow	www.wago.com/2009-145/000-002
/	Item no.: 2009-145/000-005 Mini-WSB Inline; for Smart Printer; 1700 pieces on roll; stretchable 5 - 5.2 mm; plain; snap-on type; red	www.wago.com/2009-145/000-005
/	Item no.: 2009-145/000-006 Mini-WSB Inline; for Smart Printer; 1700 pieces on roll; stretchable 5 - 5.2 mm; plain; snap-on type; blue	www.wago.com/2009-145/000-006
/	Item no.: 2009-145/000-007 Mini-WSB Inline; for Smart Printer; 1700 pieces on roll; stretchable 5 - 5.2 mm; plain; snap-on type; gray	www.wago.com/2009-145/000-007
/	Item no.: 2009-145/000-012 Mini-WSB Inline; for Smart Printer; 1700 pieces on roll; stretchable 5 - 5.2 mm; plain; snap-on type; orange	www.wago.com/2009-145/000-012
/	Item no.: 2009-145/000-023 Mini-WSB Inline; for Smart Printer; 1700 pieces on roll; stretchable 5 - 5.2 mm; plain; snap-on type; green	www.wago.com/2009-145/000-023
/	Item no.: 2009-145/000-024 Mini-WSB Inline; for Smart Printer; 1700 pieces on roll; stretchable 5 - 5.2 mm; plain; snap-on type; violet	www.wago.com/2009-145/000-024
	Item no.: 2009-191 Group marker carrier	www.wago.com/2009-191















Subject to changes. Please also observe the further product documentation!



	Item no.: 2009-192 Group marker carrier	www.wago.com/2009-192
	Item no.: 2009-193 Group marker carrier	www.wago.com/2009-193
	Item no.: 2009-198 Adaptor; gray	www.wago.com/2009-198
	Item no.: 248-501 Mini-WSB marking card; as card; not stretchable; plain; snap-on type; white	www.wago.com/248-501
	Item no.: 248-501/000-002 Mini-WSB marking card; as card; not stretchable; plain; snap-on type; yellow	www.wago.com/248-501/000-002
	Item no.: 248-501/000-005 Mini-WSB marking card; as card; not stretchable; plain; snap-on type; red	www.wago.com/248-501/000-005
	Item no.: 248-501/000-006 Mini-WSB marking card; as card; not stretchable; plain; snap-on type; blue	www.wago.com/248-501/000-006
	Item no.: 248-501/000-007 Mini-WSB marking card; as card; not stretchable; plain; snap-on type; gray	www.wago.com/248-501/000-007
	Item no.: 248-501/000-012 Mini-WSB marking card; as card; not stretchable; plain; snap-on type; orange	www.wago.com/248-501/000-012
	Item no.: 248-501/000-017 Mini-WSB marking card; as card; not stretchable; plain; snap-on type; light green	www.wago.com/248-501/000-017
	Item no.: 248-501/000-023 Mini-WSB marking card; as card; not stretchable; plain; snap-on type; green	www.wago.com/248-501/000-023
	Item no.: 248-501/000-024 Mini-WSB marking card; as card; not stretchable; plain; snap-on type; violet	www.wago.com/248-501/000-024
	Item no.: 793-501 WMB marking card; as card; not stretchable; plain; snap-on type; white	www.wago.com/793-501
	Item no.: 793-501/000-002 WMB marking card; as card; not stretchable; plain; snap-on type; yellow	www.wago.com/793-501/000-002

Subject to changes. Please also observe the further product documentation!





	Item no.: 793-501/000-005 WMB marking card; as card; not stretchable; plain; snap-on type; red	www.wago.com/793-501/000-005
	Item no.: 793-501/000-006 WMB marking card; as card; not stretchable; plain; snap-on type; blue	www.wago.com/793-501/000-006
	Item no.: 793-501/000-007 WMB marking card; as card; not stretchable; plain; snap-on type; gray	www.wago.com/793-501/000-007
	Item no.: 793-501/000-012 WMB marking card; as card; not stretchable; plain; snap-on type; orange	www.wago.com/793-501/000-012
	Item no.: 793-501/000-017 WMB marking card; as card; not stretchable; plain; snap-on type; light green	www.wago.com/793-501/000-017
	Item no.: 793-501/000-023 WMB marking card; as card; not stretchable; plain; snap-on type; green	www.wago.com/793-501/000-023
	Item no.: 793-501/000-024 WMB marking card; as card; not stretchable; plain; snap-on type; violet	www.wago.com/793-501/000-024
	Item no.: 793-5501 WMB marking card; as card; for terminal block width 5 - 17.5 mm; stretchable 5 - 5.2 mm; plain; snap-on type; white	www.wago.com/793-5501
	Item no.: 793-5501/000-002 WMB marking card; as card; for terminal block width 5 - 17.5 mm; stretchable 5 - 5.2 mm; plain; snap-on type; yellow	www.wago.com/793-5501/000-002
	Item no.: 793-5501/000-005 WMB marking card; as card; for terminal block width 5 - 17.5 mm; stretchable 5 - 5.2 mm; plain; snap-on type; red	www.wago.com/793-5501/000-005
	Item no.: 793-5501/000-006 WMB marking card; as card; for terminal block width 5 - 17.5 mm; stretchable 5 - 5.2 mm; plain; snap-on type; blue	www.wago.com/793-5501/000-006
	Item no.: 793-5501/000-007 WMB marking card; as card; for terminal block width 5 - 17.5 mm; stretchable 5 - 5.2 mm; plain; snap-on type; gray	www.wago.com/793-5501/000-007
	Item no.: 793-5501/000-012 WMB marking card; as card; for terminal block width 5 - 17.5 mm; stretchable 5 - 5.2 mm; plain; snap-on type; orange	www.wago.com/793-5501/000-012
	Item no.: 793-5501/000-014 WMB marking card; as card; for terminal block width 5 - 17.5 mm; stretchable 5 - 5.2 mm; plain; snap-on	

Subject to changes. Please also observe the further product documentation!

type; brown

www.wago.com/793-5501/000-014

	Item no.: 793-5501/000-017 WMB marking card; as card; for terminal block width 5 - 17.5 mm; stretchable 5 - 5.2 mm; plain; snap-on type; green	www.wago.com/793-5501/000-017
---	--	--

	Item no.: 793-5501/000-023 WMB marking card; as card; for terminal block width 5 - 17.5 mm; stretchable 5 - 5.2 mm; plain; snap-on type; light green	www.wago.com/793-5501/000-023
---	--	--

	Item no.: 793-5501/000-024 WMB marking card; as card; for terminal block width 5 - 17.5 mm; stretchable 5 - 5.2 mm; plain; snap-on type; violet	www.wago.com/793-5501/000-024
---	---	--

Carrier rail

	Item no.: 210-112 Steel carrier rail; 35 x 7.5 mm; 1 mm thick; 2 m long; slotted; according to EN 60715; "Hole width 25 mm; silver-colored	www.wago.com/210-112
---	--	--

	Item no.: 210-113 Steel carrier rail; 35 x 7.5 mm; 1 mm thick; 2 m long; unslotted; according to EN 60715; silver-colored	www.wago.com/210-113
---	---	--

	Item no.: 210-114 Steel carrier rail; 35 x 15 mm; 1.5 mm thick; 2 m long; unslotted; similar to EN 60715; silver-colored	www.wago.com/210-114
---	--	--

	Item no.: 210-115 Steel carrier rail; 35 x 7.5 mm; 1 mm thick; 2 m long; slotted; according to EN 60715; "Hole width 18 mm; silver-colored	www.wago.com/210-115
---	--	--

	Item no.: 210-118 Steel carrier rail; 35 x 15 mm; 2.3 mm thick; 2 m long; unslotted; according to EN 60715; silver-colored	www.wago.com/210-118
---	--	--

	Item no.: 210-196 Aluminum carrier rail; 35 x 8.2 mm; 1.6 mm thick; 2 m long; unslotted; similar to EN 60715; silver-colored	www.wago.com/210-196
---	--	--

	Item no.: 210-197 Steel carrier rail; 35 x 15 mm; 1.5 mm thick; 2 m long; slotted; similar to EN 60715; silver-colored	www.wago.com/210-197
---	--	--

	Item no.: 210-198 Copper carrier rail; 35 x 15 mm; 2.3 mm thick; 2 m long; unslotted; according to EN 60715; copper-colored	www.wago.com/210-198
---	---	--















	Item no.: 210-504 Steel carrier rail; 35 x 7.5 mm; 1 mm thick; 2 m long; slotted; galvanized; according to EN 60715; silver-colored	www.wago.com/210-504
---	---	--

	Item no.: 210-505 Steel carrier rail; 35 x 7.5 mm; 1 mm thick; 2 m long; unslotted; galvanized; according to EN 60715; silver-colored	www.wago.com/210-505
---	---	--

















	Item no.: 210-506 Steel carrier rail; 35 x 15 mm; 1.5 mm thick; 2 m long; unslotted; galvanized; similar to EN 60715; silver-colored	www.wago.com/210-506
---	--	--

Item no.: 210-508















Subject to changes. Please also observe the further product documentation!

	Steel carrier rail; 35 x 15 mm; 1.5 mm thick; 2 m long; slotted; galvanized; similar to EN 60715; silver-colored	www.wago.com/210-508
Ferrules		
	Item no.: 216-241 Ferrule; Sleeve for 0.5 mm ² / 20 AWG; insulated; electro-tin plated; electrolytic copper; gastight crimped; acc. to DIN 46228, Part 4/09.90; white	www.wago.com/216-241
	Item no.: 216-242 Ferrule; Sleeve for 0.75 mm ² / 18 AWG; insulated; electro-tin plated; electrolytic copper; gastight crimped; acc. to DIN 46228, Part 4/09.90; gray	www.wago.com/216-242
	Item no.: 216-243 Ferrule; Sleeve for 1 mm ² / AWG 18; insulated; electro-tin plated; electrolytic copper; gastight crimped; acc. to DIN 46228, Part 4/09.90; red	www.wago.com/216-243
	Item no.: 216-244 Ferrule; Sleeve for 1.5 mm ² / AWG 16; insulated; electro-tin plated; electrolytic copper; gastight crimped; acc. to DIN 46228, Part 4/09.90; black	www.wago.com/216-244
	Item no.: 216-246 Ferrule; Sleeve for 2.5 mm ² / AWG 14; insulated; electro-tin plated; electrolytic copper; gastight crimped; acc. to DIN 46228, Part 4/09.90; blue	www.wago.com/216-246
	Item no.: 216-262 Ferrule; Sleeve for 0.75 mm ² / 18 AWG; insulated; electro-tin plated; electrolytic copper; gastight crimped; acc. to DIN 46228, Part 4/09.90; gray	www.wago.com/216-262
	Item no.: 216-263 Ferrule; Sleeve for 1 mm ² / AWG 18; insulated; electro-tin plated; electrolytic copper; gastight crimped; acc. to DIN 46228, Part 4/09.90; red	www.wago.com/216-263
	Item no.: 216-264 Ferrule; Sleeve for 1.5 mm ² / AWG 16; insulated; electro-tin plated; electrolytic copper; gastight crimped; acc. to DIN 46228, Part 4/09.90; black	www.wago.com/216-264
	Item no.: 216-266 Ferrule; Sleeve for 2.5 mm ² / AWG 14; insulated; electro-tin plated; electrolytic copper; gastight crimped; acc. to DIN 46228, Part 4/09.90; blue	www.wago.com/216-266
Insulations stops		
	Item no.: 2002-171 TOPJOB®S insulation stop; for 2002 series terminal blocks; 0.25 - 0.5 mm ² ; 5/strip; light gray	www.wago.com/2002-171
	Item no.: 2002-172 TOPJOB®S insulation stop; for 2002 series terminal blocks; 0.75 - 1.0 mm ² ; 5/strip; dark gray	www.wago.com/2002-172
Testing accessories		
	Item no.: 2002-511 TOPJOB®S modular connector; for 2002 series; for jumper contact slot; 1-pole; gray	www.wago.com/2002-511
	Item no.: 2002-549 TOPJOB®S spacer module; for 2002-511; 5.2 mm wide; gray	www.wago.com/2002-549
	Item no.: 2002-552 TOPJOB®S connector strip; for 2002 series; for jumper contact slot; 2-pole; gray	www.wago.com/2002-552
	Item no.: 2002-553 TOPJOB®S connector strip; for 2002 series; for jumper contact slot; 3-pole; gray	www.wago.com/2002-553















Subject to changes. Please also observe the further product documentation!

	Item no.: 2002-554 TOPJOB® S connector strip; for 2002 series; for jumper contact slot; 4-pole; gray	www.wago.com/2002-554
	Item no.: 2002-555 TOPJOB® S connector strip; for 2002 series; for jumper contact slot; 5-pole; gray	www.wago.com/2002-555
	Item no.: 2002-556 TOPJOB® S connector strip; for 2002 series; for jumper contact slot; 6-pole; gray	www.wago.com/2002-556
	Item no.: 2002-557 TOPJOB® S connector strip; for 2002 series; for jumper contact slot; 7-pole; gray	www.wago.com/2002-557
	Item no.: 2002-558 TOPJOB® S connector strip; for 2002 series; for jumper contact slot; 8-pole; gray	www.wago.com/2002-558
	Item no.: 2002-559 TOPJOB® S connector strip; for 2002 series; for jumper contact slot; 9-pole; gray	www.wago.com/2002-559
	Item no.: 2002-560 TOPJOB® S connector strip; for 2002 series; for jumper contact slot; 10-pole; gray	www.wago.com/2002-560
	Item no.: 2002-611 TOPJOB® S modular connector; for 2002 series; for conductor entry way; 1-pole; gray	www.wago.com/2002-611
	Item no.: 2002-649 TOPJOB® S spacer module; for 2002-611; 5.2 mm wide; gray	www.wago.com/2002-649
	Item no.: 2009-174 TOPJOB® S test plug adapter; for test plug 4 mm Ø; for testing TOPJOB® S terminal blocks; gray	www.wago.com/2009-174
	Item no.: 2009-182 TOPJOB® S testing tap; tool-free; 12 AWG max; for testing TOPJOB® S terminal blocks; gray	www.wago.com/2009-182
	Item no.: 210-136 Test plug; 2 mm Ø; with 500 mm cable	www.wago.com/210-136
Tools		
	Item no.: 210-658 Operating tool; Blade: 3.5 x 0.5 mm; with a partially insulated shaft; angled; short; multicoloured	www.wago.com/210-658
	Item no.: 210-720 Operating tool; Blade: 3.5 x 0.5 mm; with a partially insulated shaft; multicoloured	www.wago.com/210-720
Jumpers		
	Item no.: 2002-400 TOPJOB® S endless jumper; for 2002 series; insulated; 2-way; light-gray	www.wago.com/2002-400
	Item no.: 2002-402 TOPJOB® S jumper; for 2002 series; insulated; 2-way; light-gray	www.wago.com/2002-402
	Item no.: 2002-402/000-005 TOPJOB® S jumper; for 2002 series; insulated; 2-way; red	www.wago.com/2002-402/000-005

















Subject to changes. Please also observe the further product documentation!

	Item no.: 2002-402/000-006 TOPJOB®S jumper; for 2002 series; insulated; 2-way; blue	www.wago.com/2002-402/000-006
	Item no.: 2002-403 TOPJOB®S jumper; for 2002 series; insulated; 3-way; light-gray	www.wago.com/2002-403
	Item no.: 2002-403/000-005 TOPJOB®S jumper; for 2002 series; insulated; 3-way; red	www.wago.com/2002-403/000-005
	Item no.: 2002-403/000-006 TOPJOB®S jumper; for 2002 series; insulated; 3-way; blue	www.wago.com/2002-403/000-006
	Item no.: 2002-404 TOPJOB®S jumper; for 2002 series; insulated; 4-way; light-gray	www.wago.com/2002-404
	Item no.: 2002-404/000-005 TOPJOB®S jumper; for 2002 series; insulated; 4-way; red	www.wago.com/2002-404/000-005
	Item no.: 2002-404/000-006 TOPJOB®S jumper; for 2002 series; insulated; 4-way; blue	www.wago.com/2002-404/000-006
	Item no.: 2002-405 TOPJOB®S jumper; for 2002 series; insulated; 5-way; light-gray	www.wago.com/2002-405
	Item no.: 2002-405/000-005 TOPJOB®S jumper; for 2002 series; insulated; 5-way; red	www.wago.com/2002-405/000-005
	Item no.: 2002-405/000-006 TOPJOB®S jumper; for 2002 series; insulated; 5-way; blue	www.wago.com/2002-405/000-006
	Item no.: 2002-405/011-000 TOPJOB®S jumper; Wye configuration; for 2002 series; insulated; 3-way (1-3-5); light-gray	www.wago.com/2002-405/011-000
	Item no.: 2002-406 TOPJOB®S jumper; for 2002 series; insulated; 6-way; light-gray	www.wago.com/2002-406
	Item no.: 2002-406/000-005 TOPJOB®S jumper; for 2002 series; insulated; 6-way; red	www.wago.com/2002-406/000-005
	Item no.: 2002-406/000-006 TOPJOB®S jumper; for 2002 series; insulated; 6-way; blue	www.wago.com/2002-406/000-006

Subject to changes. Please also observe the further product documentation!

	Item no.: 2002-406/020-000 TOPJOB®S jumper; Delta configuration; for 2002 series; insulated; 6-way (1-2, 3-4, 5-6); light-gray	www.wago.com/2002-406/020-000
	Item no.: 2002-407 TOPJOB®S jumper; for 2002 series; insulated; 7-way; light-gray	www.wago.com/2002-407
	Item no.: 2002-407/000-005 TOPJOB®S jumper; for 2002 series; insulated; 7-way; red	www.wago.com/2002-407/000-005
	Item no.: 2002-407/000-006 TOPJOB®S jumper; for 2002 series; insulated; 7-way; blue	www.wago.com/2002-407/000-006
	Item no.: 2002-408 TOPJOB®S jumper; for 2002 series; insulated; 8-way; light-gray	www.wago.com/2002-408
	Item no.: 2002-408/000-005 TOPJOB®S jumper; for 2002 series; insulated; 8-way; red	www.wago.com/2002-408/000-005
	Item no.: 2002-408/000-006 TOPJOB®S jumper; for 2002 series; insulated; 8-way; blue	www.wago.com/2002-408/000-006
	Item no.: 2002-409 TOPJOB®S jumper; for 2002 series; insulated; 9-way; light-gray	www.wago.com/2002-409
	Item no.: 2002-409/000-005 TOPJOB®S jumper; for 2002 series; insulated; 9-way; red	www.wago.com/2002-409/000-005
	Item no.: 2002-409/000-006 TOPJOB®S jumper; for 2002 series; insulated; 9-way; light-gray	www.wago.com/2002-409/000-006
	Item no.: 2002-410 TOPJOB®S jumper; for 2002 series; insulated; 10-way; light-gray	www.wago.com/2002-410
	Item no.: 2002-410/000-005 TOPJOB®S jumper; for 2002 series; insulated; 10-way; red	www.wago.com/2002-410/000-005
	Item no.: 2002-410/000-006 TOPJOB®S jumper; for 2002 series; insulated; 10-way; blue	www.wago.com/2002-410/000-006
	Item no.: 2002-423 TOPJOB®S endless jumper; for 2002 series; insulated; 2-way (1-3); light-gray	www.wago.com/2002-423
	Item no.: 2002-423/000-005 TOPJOB®S endless jumper; for 2002 series; insulated; 2-way (1-3); red	www.wago.com/2002-423/000-005

Subject to changes. Please also observe the further product documentation!

	Item no.: 2002-423/000-006 TOPJOB®S endless jumper; for 2002 series; insulated; 2-way (1-3); blue	www.wago.com/2002-423/000-006
	Item no.: 2002-433 TOPJOB®S jumper; for 2002 series; insulated; 2-way (1-3); light-gray	www.wago.com/2002-433
	Item no.: 2002-434 TOPJOB®S jumper; for 2002 series; insulated; 2-way (1-4); light-gray	www.wago.com/2002-434
	Item no.: 2002-435 TOPJOB®S jumper; for 2002 series; insulated; 2-way (1-5); light-gray	www.wago.com/2002-435
	Item no.: 2002-436 TOPJOB®S jumper; for 2002 series; insulated; 2-way (1-6); light-gray	www.wago.com/2002-436
	Item no.: 2002-437 TOPJOB®S jumper; for 2002 series; insulated; 2-way (1-7); light-gray	www.wago.com/2002-437
	Item no.: 2002-438 TOPJOB®S jumper; for 2002 series; insulated; 2-way (1-8); light-gray	www.wago.com/2002-438
	Item no.: 2002-439 TOPJOB®S jumper; for 2002 series; insulated; 2-way (1-9); light-gray	www.wago.com/2002-439
	Item no.: 2002-440 TOPJOB®S jumper; for 2002 series; insulated; 2-way (1-10); light-gray	www.wago.com/2002-440
	Item no.: 2002-472 TOPJOB®S staggered jumper; for 2002 and 2003 series; insulated; 2-way; light-gray	www.wago.com/2002-472
	Item no.: 2002-473 TOPJOB®S staggered jumper; for 2002 and 2003 series; insulated; 3-way; light-gray	www.wago.com/2002-473
	Item no.: 2002-473/011-000 TOPJOB®S staggered jumper; for 2002 and 2003 series; 2-way (preconfigured 1-3); light-gray	www.wago.com/2002-473/011-000
	Item no.: 2002-474 TOPJOB®S staggered jumper; for 2002 and 2003 series; insulated; 4-way; light-gray	www.wago.com/2002-474
	Item no.: 2002-475 TOPJOB®S staggered jumper; for 2002 and 2003 series; insulated; 5-way; light-gray	www.wago.com/2002-475
	Item no.: 2002-475/011-000 TOPJOB®S staggered jumper; for 2002 and 2003 series; insulated; 3-way (preconfigured 1-3-5); light-gray	www.wago.com/2002-475/011-000
	Item no.: 2002-476 TOPJOB®S staggered jumper; for 2002 and 2003 series; insulated; 6-way; light-gray	www.wago.com/2002-476
	Item no.: 2002-477 TOPJOB®S staggered jumper; for 2002 and 2003 series; insulated; 7-way; light-gray	www.wago.com/2002-477

Subject to changes. Please also observe the further product documentation!



	Item no.: 2002-477/011-000 TOPJOB®S staggered jumper; for 2002 and 2003 series; insulated; 4-way (preconfigured 1-3-5-7); light-gray	www.wago.com/2002-477/011-000
	Item no.: 2002-478 TOPJOB®S staggered jumper; for 2002 and 2003 series; insulated; 8-way; light-gray	www.wago.com/2002-478
	Item no.: 2002-479 TOPJOB®S staggered jumper; for 2002 and 2003 series; insulated; 9-way; light-gray	www.wago.com/2002-479
	Item no.: 2002-479/011-000 TOPJOB®S staggered jumper; for 2002 and 2003 series; insulated; 5-way (preconfigured 1-3-5-7-9); light-gray	www.wago.com/2002-479/011-000
	Item no.: 2002-480 TOPJOB®S staggered jumper; for 2002 and 2003 series; insulated; 10-way; light-gray	www.wago.com/2002-480
	Item no.: 2002-481 TOPJOB®S staggered jumper; for 2002 and 2003 series; insulated; 11-way; light-gray	www.wago.com/2002-481
	Item no.: 2002-481/011-000 TOPJOB®S staggered jumper; for 2002 and 2003 series; insulated; 6-way (preconfigured 1-3-5-7-9-11); light-gray	www.wago.com/2002-481/011-000
	Item no.: 2002-482 TOPJOB®S staggered jumper; for 2002 and 2003 series; insulated; 12-way; light-gray	www.wago.com/2002-482
	Item no.: 210-103 Wire commoning chain; insulated; black	www.wago.com/210-103
	Item no.: 210-123 Wire commoning chain; insulated; blue	www.wago.com/210-123
Push-in type wire jumper		
	Item no.: 2009-412 TOPJOB®S wire jumper; insulated; 60 mm long; conductor cross section 1.5 mm ² ; suitable for 2001, 2002, 2003 and 2022 series terminal blocks; gray	www.wago.com/2009-412
	Item no.: 2009-414 TOPJOB®S wire jumper; insulated; 110 mm long; conductor cross section 1.5 mm ² ; suitable for 2001, 2002, 2003 and 2022 series terminal blocks; gray	www.wago.com/2009-414
	Item no.: 2009-414/000-005 Push-in type wire jumper; 1.5 mm ² ; insulated; 110 mm long; black	www.wago.com/2009-414/000-005
	Item no.: 2009-414/000-006 Push-in type wire jumper; insulated; 110 mm long; black	www.wago.com/2009-414/000-006
	Item no.: 2009-416 TOPJOB®S wire jumper; insulated; 250 mm long; conductor cross section 1.5 mm ² ; suitable for 2001, 2002, 2003 and 2022 series terminal blocks; gray	www.wago.com/2009-416

Subject to changes. Please also observe the further product documentation!

Downloads
Documentation

Bid Text

2202-1881 X81 - Datei	May 20, 2019	xml 4.5 kB	Download
--------------------------	--------------	---------------	----------

2202-1881 docx - Datei	May 20, 2019	docx 16.2 kB	Download
---------------------------	--------------	-----------------	----------

Additional Information

Technical explanations	Apr 3, 2019	pdf 2.2 MB	Download
------------------------	-------------	---------------	----------

Environmental Product Compliance

Compliance Search

Environmental Product Compliance 2202-1881 4-conductor fuse terminal block; for mini-automotive blade-style fuses; per DIN 7258-3f, ISO 8820-3; with test option; with push-button; without blown fuse indication; 2.5 mm ² ; Push-in CAGE CLAMP®; 2,50 mm ² ; gray	URL	Download
--	-----	----------

Installation Notes

Conductor termination

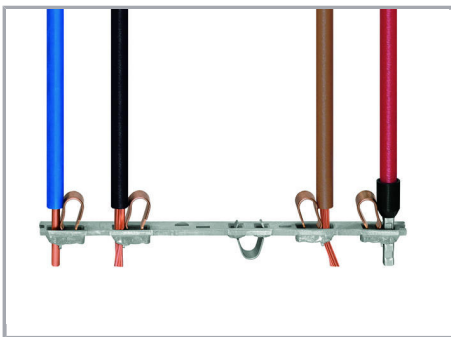

All conductor types at a glance

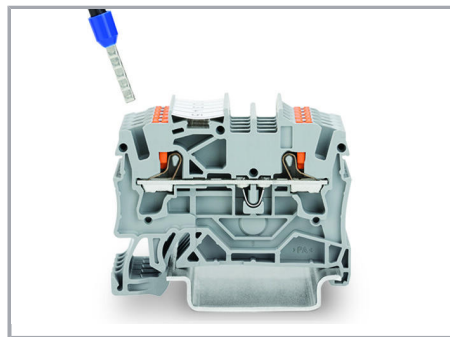

Push-in termination of solid and ferruled conductors



Push-in termination of solid and ferruled conductors

Subject to changes. Please also observe the further product documentation!



Insert fine-stranded conductors via operating tool.



Removing all conductors via operating tool.

Commoning

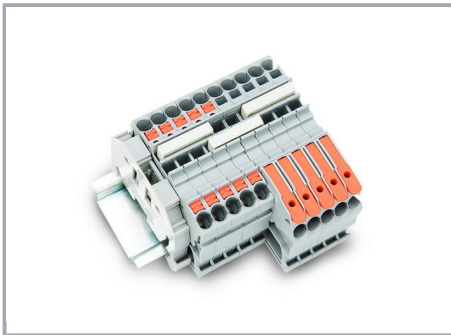

Insert a push-in type jumper bar and push down until it hits the backstop.



Application Notes on Terminal Blocks for Glass Cartridge Fuses

Diagram: "Individual Arrangement"

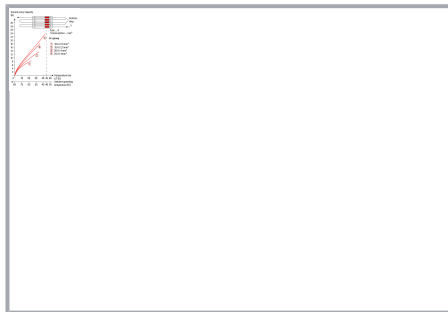

Application Notes on Terminal Blocks for Glass Cartridge Fuses

Diagram: "Block Arrangement"

Subject to changes. Please also observe the further product documentation!

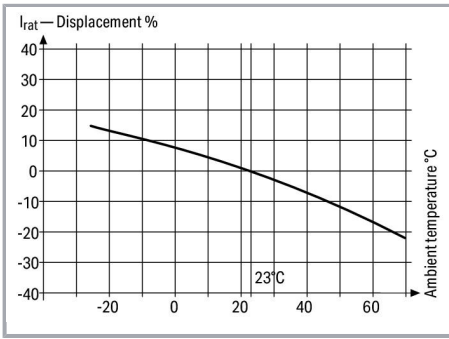

Application Notes on Terminal Blocks for Glass Cartridge Fuses

Nominal current ratings for fuse cartridges are defined differently in international standards. This is why the recommended continuous current-carrying capacity of the fuses is a max. 80% of their nominal current according to DIN 72581/Part 3 (for a surrounding air temperature of 23°C).

Selecting the correct fuse cartridge is important for product safety within applications, as well as for fuse cartridge service life and reliability. Fuse cartridges will only operate perfectly as protection components (break-off point) if they are properly selected and used as intended (i.e., according to the state of the technology and valid specifications, as well as data sheet characteristics), according to basic safety requirements (i.e., persons, animals and property must be protected against hazards).

Concerning product safety, fuse cartridges must generally be tested under both normal and faulty operating conditions within your application.

Marking

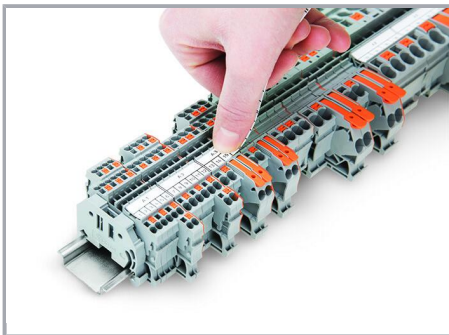

Snapping a marking strip into a marker slot.

Snapping a marking strip into the marker slot.

Subject to changes. Please also observe the further product documentation!



Product family

TOPJOB® S

TOPJOB® S: In various industrial applications and modern building installations, WAGO's wide and versatile range of rail-mount terminal blocks provides more than just reliable electrical connections.

[Show all products from the family](#)

Subject to changes. Please also observe the further product documentation!

WAGO Corporation
Germantown, WI 53022
Phone: 1-800-DIN-RAIL (346-7245) | Fax: (262) 255-6222
Email: info.us@wago.com | Web: www.wago.us

Do you have any questions about our products?
We are always happy to take your call at (262) 255-6222 or 1 800-DIN-RAIL.